

Add: CN6 Far East Industrial Park, Yuyao, Zhejiang, P.R.China

Tel: 0086-574-62760092 62760098

Fax: 0086-574-62760097

E-Mail: Jane@fourstarlamps.com Janefsl@163.com

Alice@fourstarlamps.com Alice.3@163.com

<http://www.chinalamp.com>

<http://www.fourstarlamps.com>



★
★
★
★
FOUR STAR LAMPS VERSION D-1

 余姚市四星灯具有限公司
YUYAO FOUR STAR LAMPS CO.,LTD.



Our company has
registered trademarks:

TIHI 霆翰®

花园之星®

WEIKWEI 威克威®

庭院之星®



COMPANY PROFILE

Yuyao Four Star Lamps Co.,Ltd. is a company specializing in the production of outdoor lighting with artwork aluminum die casting, stamping and extrusion of aluminum, copper and stainless steel material.

Our company has the self-management of import and export rights. We have the capacity to complete the whole manufacturing process of lamps. Now there are 12 units of 500 t, 250 t, 160 t die-casting machines etc., 2 powder coating curing and 6 final assembly lines , annual production capacity of aluminum alloy die casting, copper alloy die-casting, zinc alloy die casting hydraulic tensile, spinning forming, cold punching forming of moisture-proof lamps and lanterns, the courtyard lamps, lawn lamps and accessories more than 400 sets.

The company since its establishment, has accumulated rich production experience and technical ability, complete production equipment, exquisite process operation. Our company has the ROHS testing equipment to control production quality, and quality inspector team monitor carefully from the product material, accessories to make sure the high guarantee of quality. Our products have CE/ETL certification and China CCC certification.

Four Star gathered a batch of outstanding talent, strong team ensures Four Star management and the production efficiency.

Four Star insist to protect the intellectual property rights of clients, focus on cooperation with domestic and foreign customers to map, sample products, joint investment, joint development market, with good reputation and sincere service, we have cooperated with the companies from the United States, Germany and Japan who do OEM/ODM for many years.

You are welcome to contact us, become one of our partners.



2001



2005



2001G

2001AG

2004

2003

2004

Product feature:

- *Die Cast Aluminum Body
- *UV Resistant Powder Coating
- *Glass diffuser
- *Brass or Stainless Steel Fasten Parts

110V~240V/AC 50Hz/60Hz
 Max 60W E26/E27

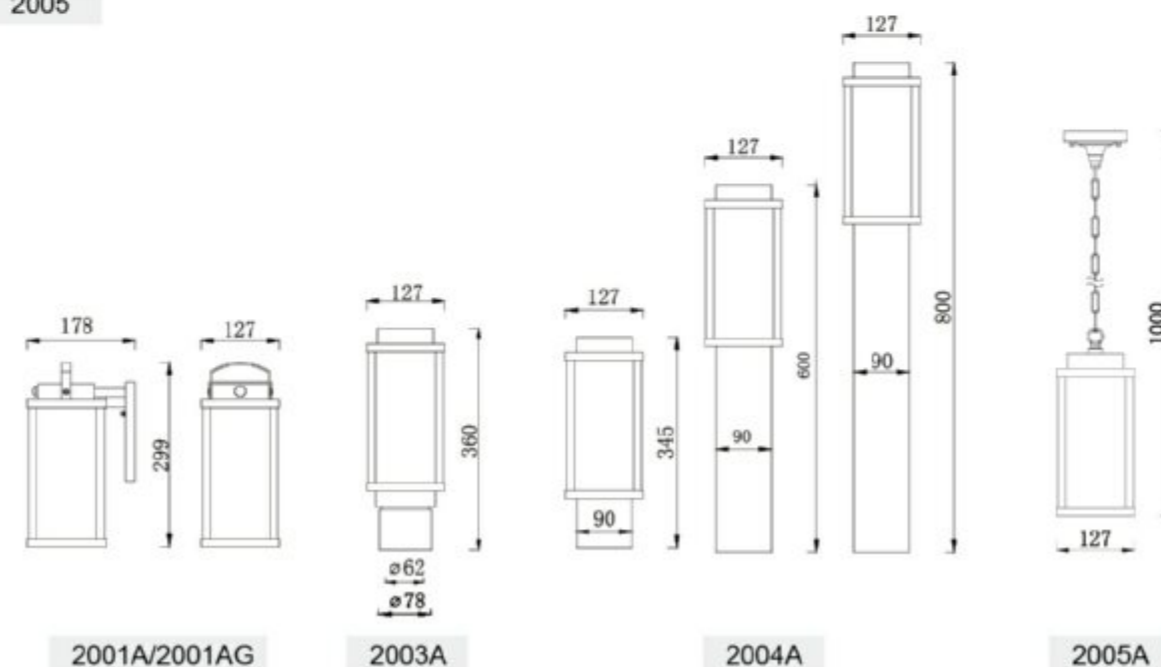
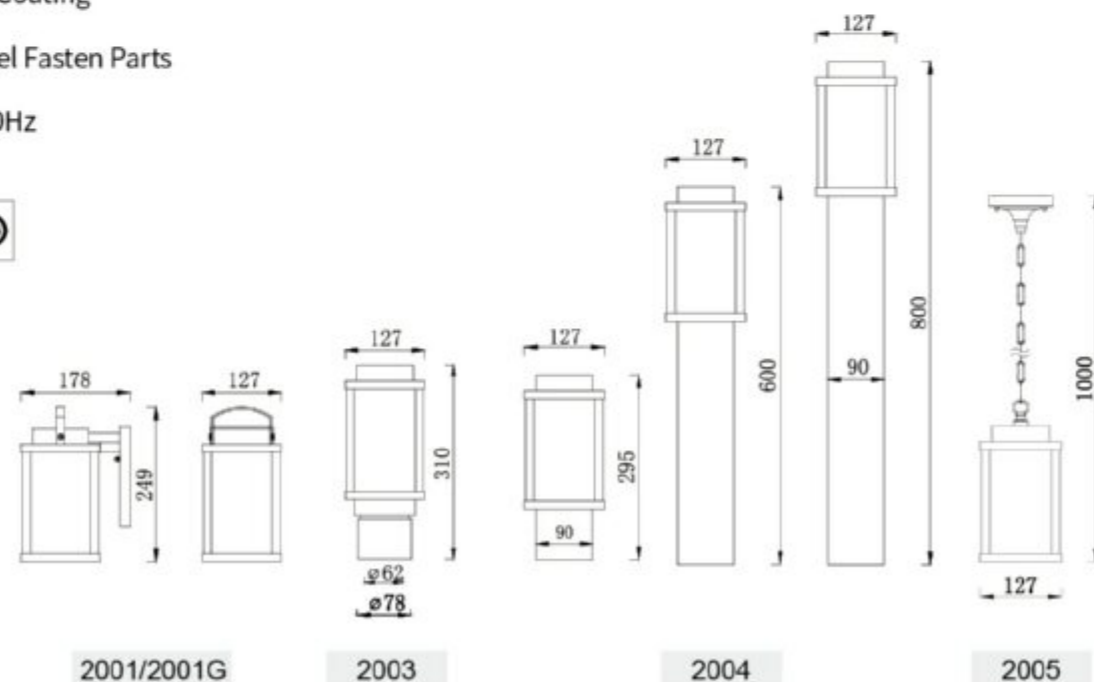



Product feature:

- *Die Cast Aluminum Body
- *UV Resistant Powder Coating
- *Glass diffuser
- *Brass or Stainless Steel Fasten Parts

110V~240V/AC 50Hz/60Hz
 Max 60W E26/E27

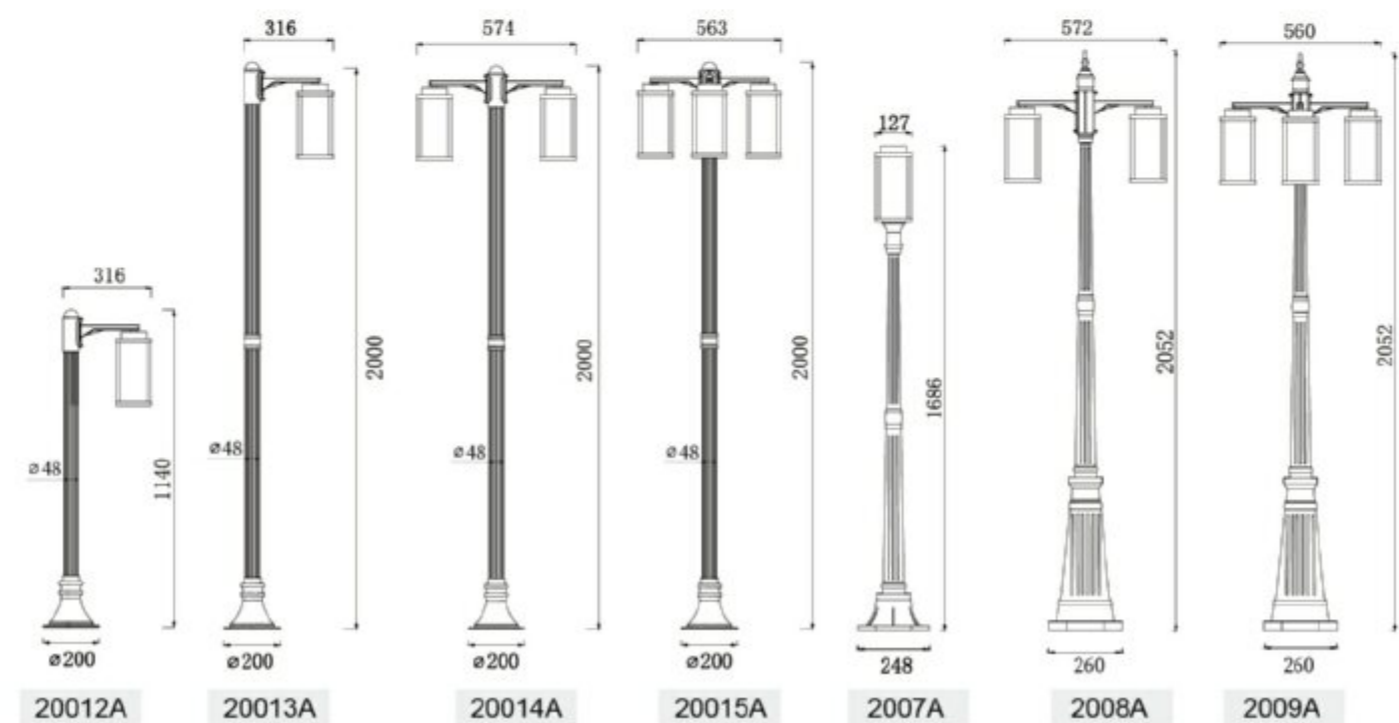
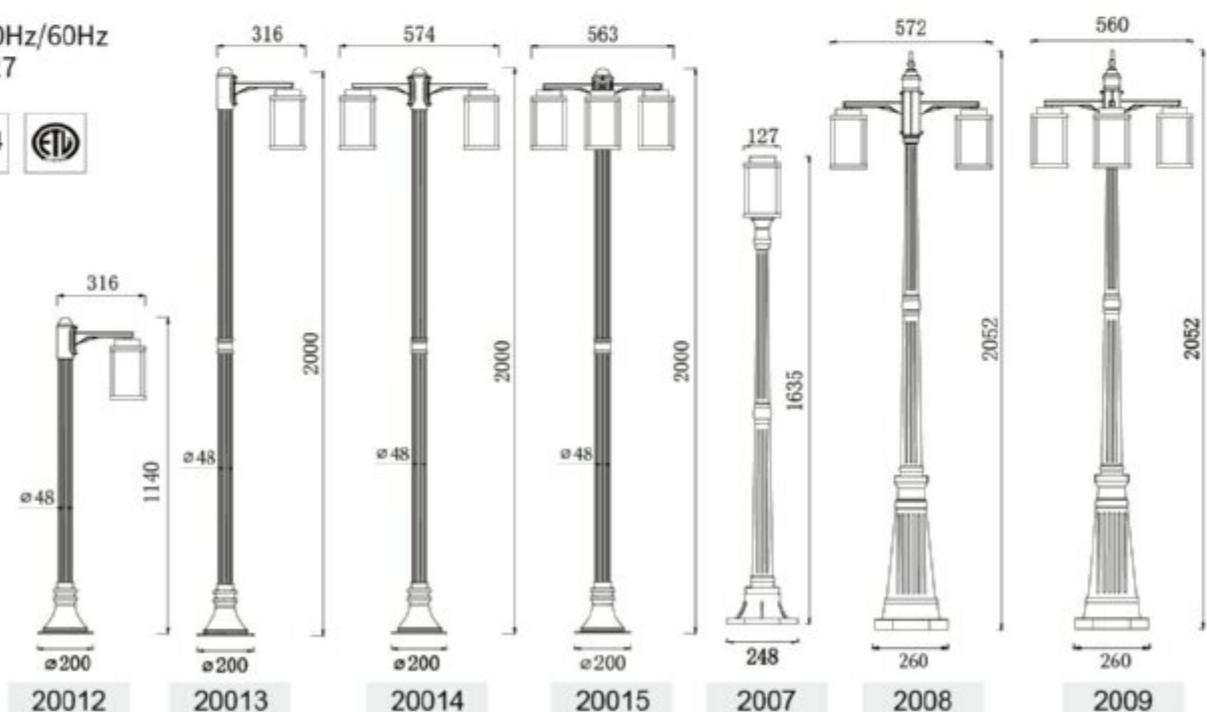



squirrel



window

2011



2011



2013



2014



2015

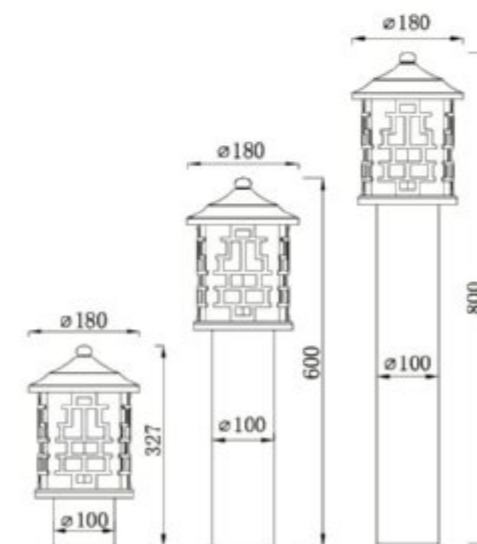

2014

Product feature:

- *Die Cast Aluminum Body
- *UV Resistant Powder Coating
- *Glass diffuser
- *Brass or Stainless Steel Fasten Parts

110V~240V/AC 50Hz/60Hz
 Max 60W E26/E27

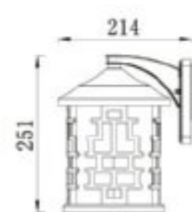

2011

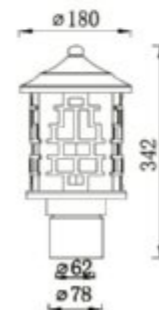

2013

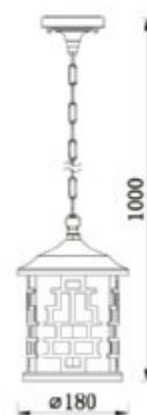

2015



Product feature:

- *Die Cast Aluminum Body
- *UV Resistant Powder Coating
- *Glass diffuser
- *Brass or Stainless Steel Fasten Parts

110V~240V/AC 50Hz/60Hz
 Max 60W E26/E27

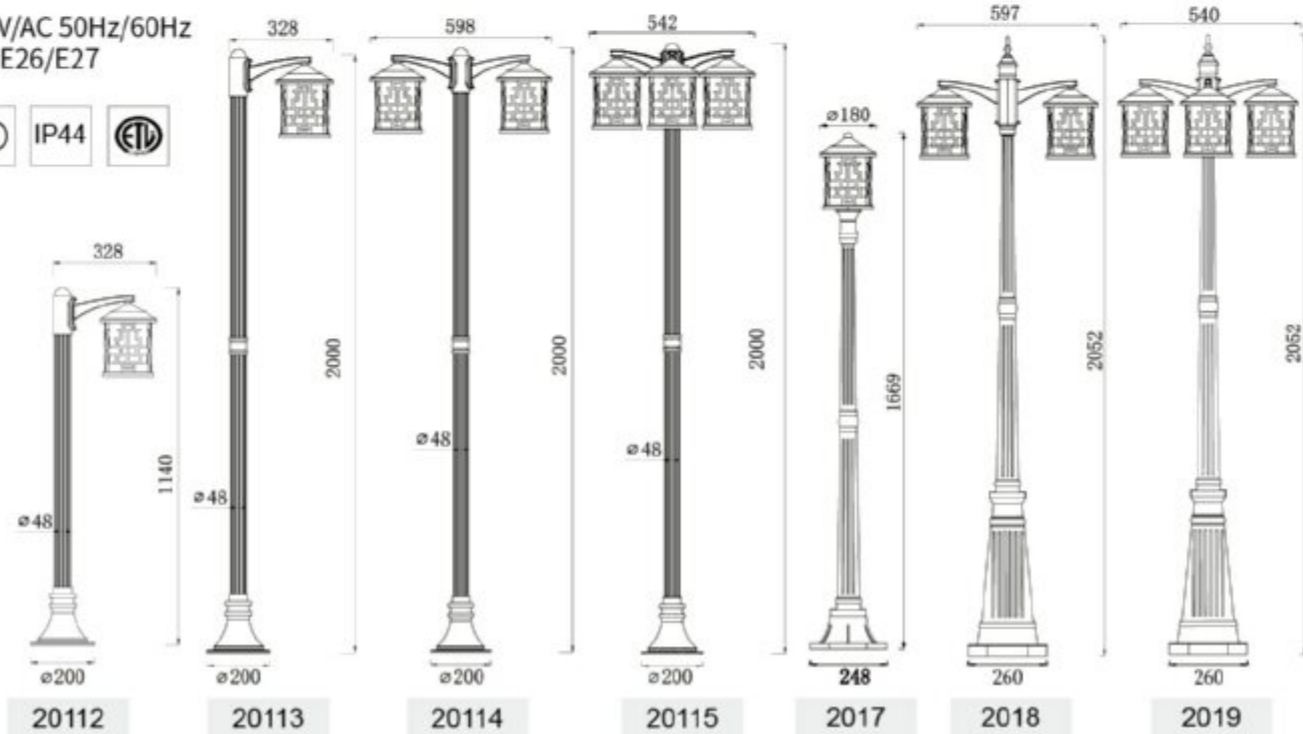



Product feature:

- *Die Cast Aluminum Body
- *UV Resistant Powder Coating
- *Glass diffuser
- *Brass or Stainless Steel Fasten Parts

110V~240V/AC 50Hz/60Hz
 Max 60W E26/E27

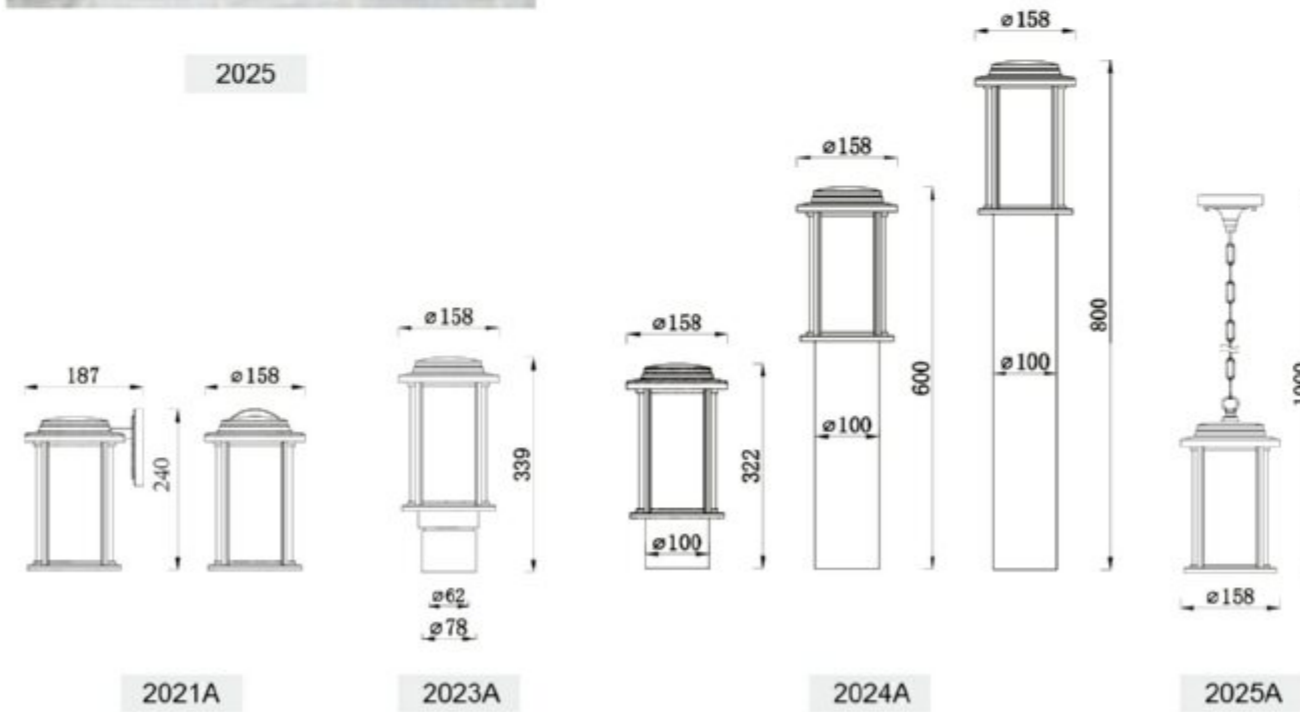
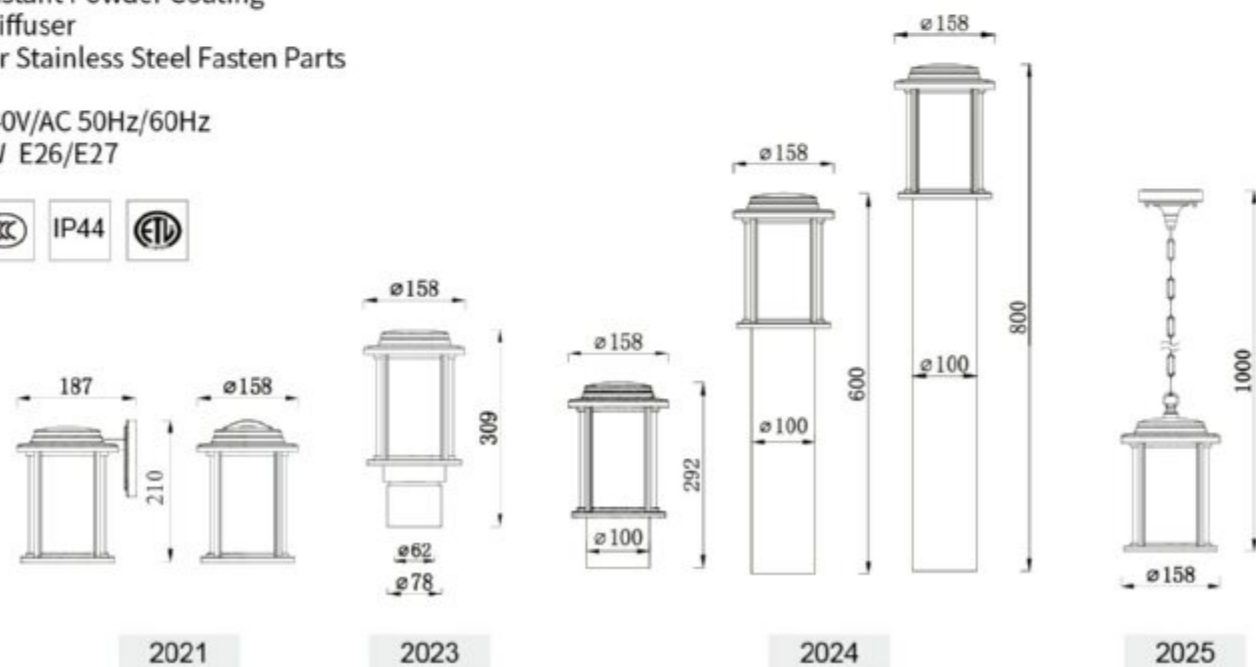



Product feature:

- *Die Cast Aluminum Body
- *UV Resistant Powder Coating
- *Glass diffuser
- *Brass or Stainless Steel Fasten Parts

110V~240V/AC 50Hz/60Hz
 Max 60W E26/E27

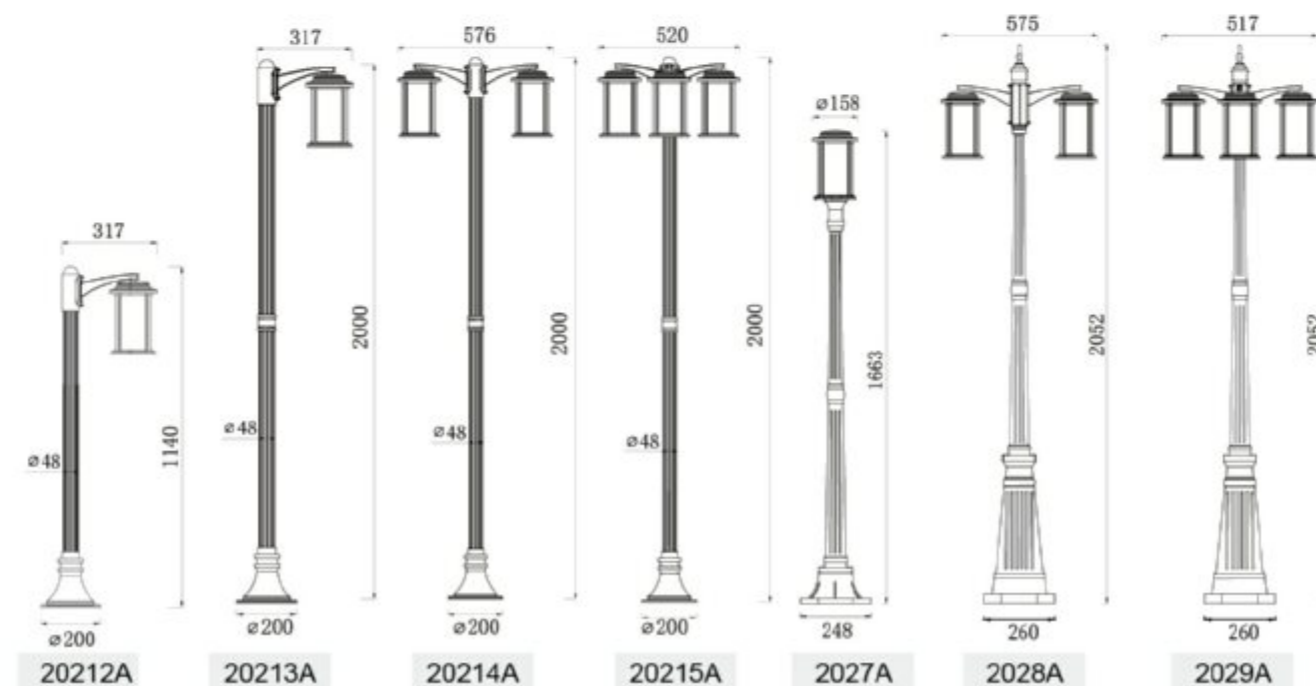
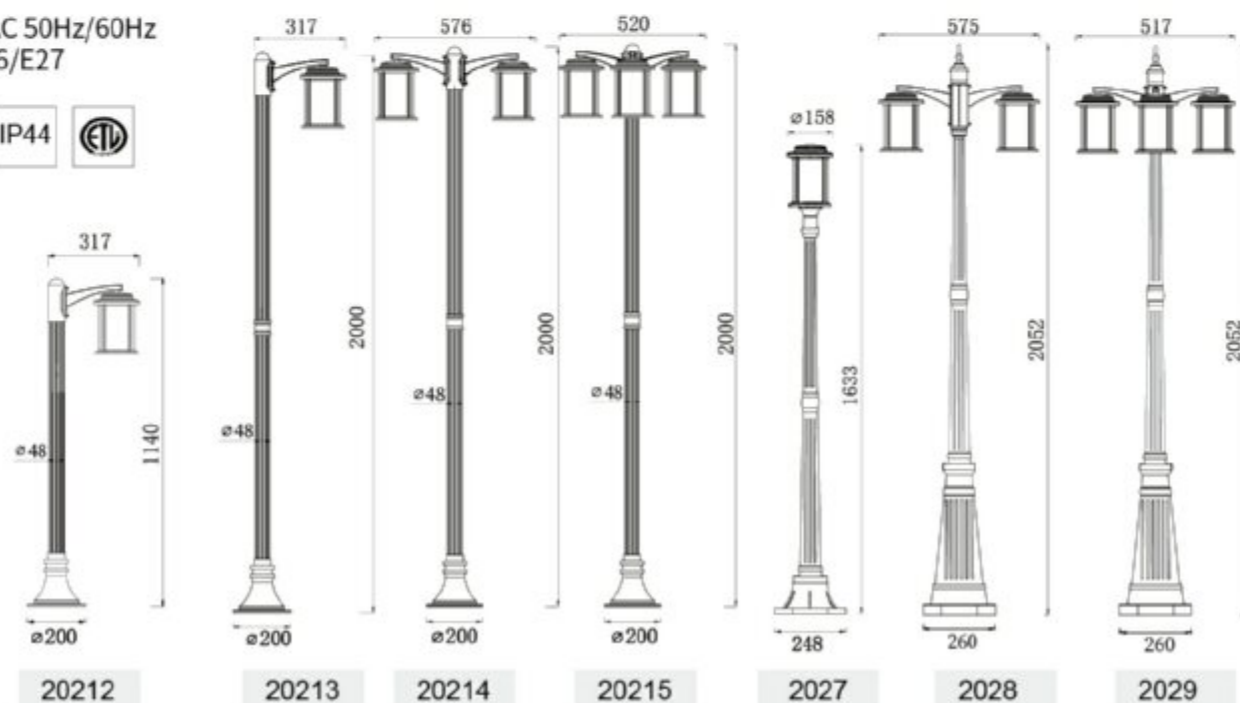



2031



2033

2034



2035

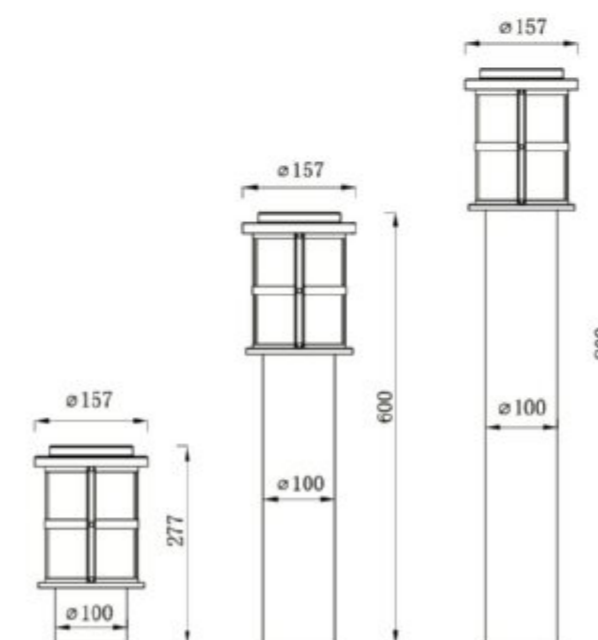

2034

Product feature:

- *Die Cast Aluminum Body
- *UV Resistant Powder Coating
- *Glass diffuser
- *Brass or Stainless Steel Fasten Parts

110V~240V/AC 50Hz/60Hz
 Max 60W E26/E27

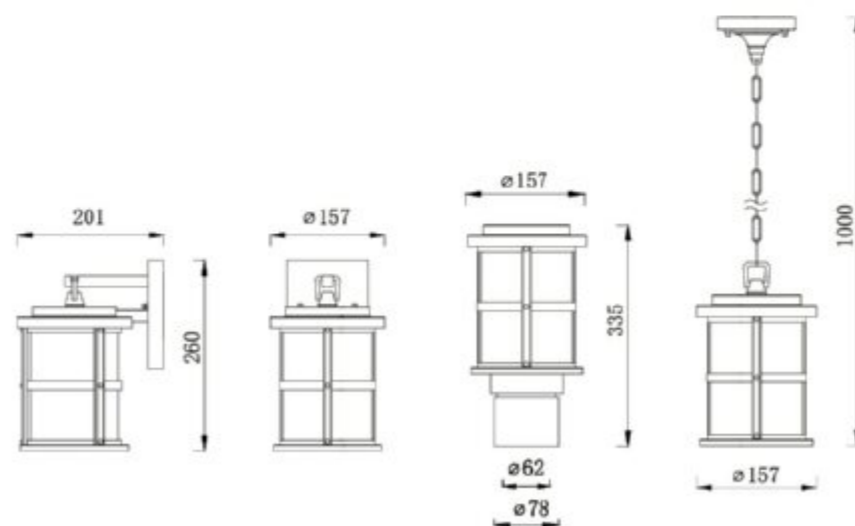

2031

2033

2035



Product feature:

- *Die Cast Aluminum Body
- *UV Resistant Powder Coating
- *Glass diffuser
- *Brass or Stainless Steel Fasten Parts

110V~240V/AC 50Hz/60Hz
 Max 60W E26/E27

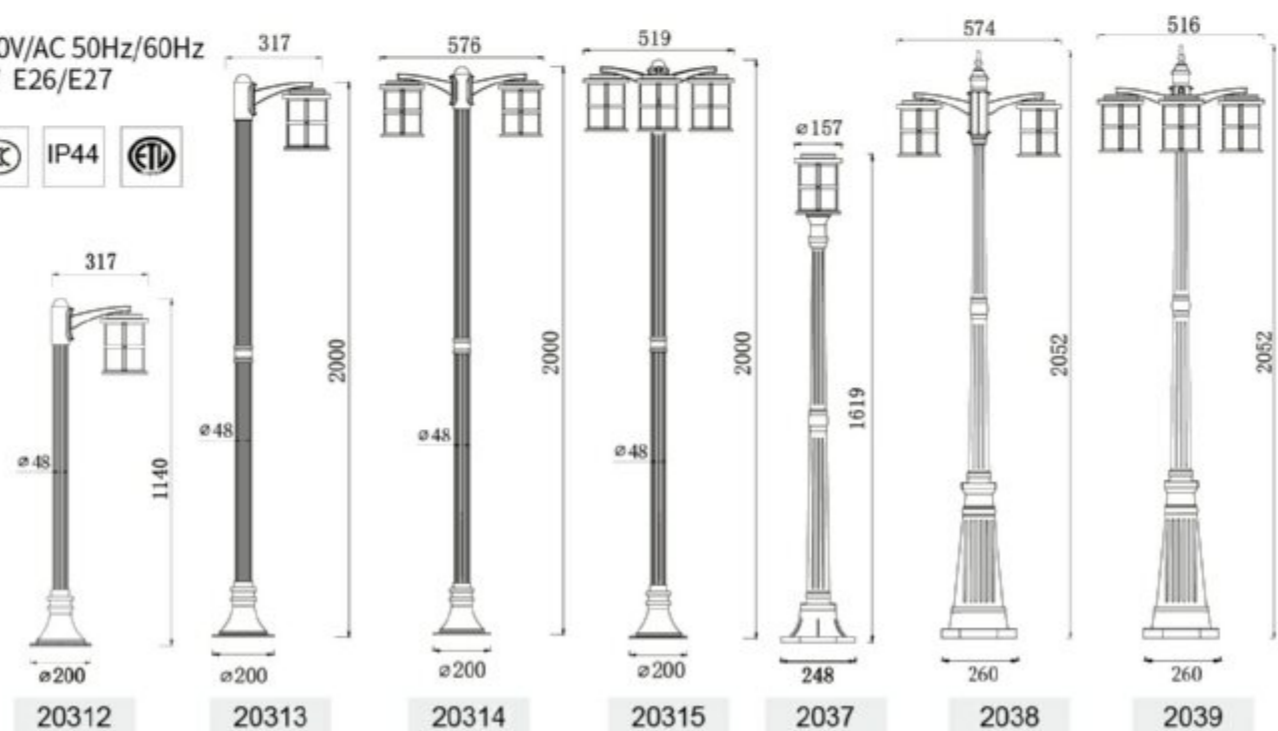



2041



2045A



2043A

2044

Product feature:

- *Die Cast Aluminum Body
- *UV Resistant Powder Coating
- *Glass diffuser
- *Brass or Stainless Steel Fasten Parts

110V~240V/AC 50Hz/60Hz
 Max 60W E26/E27

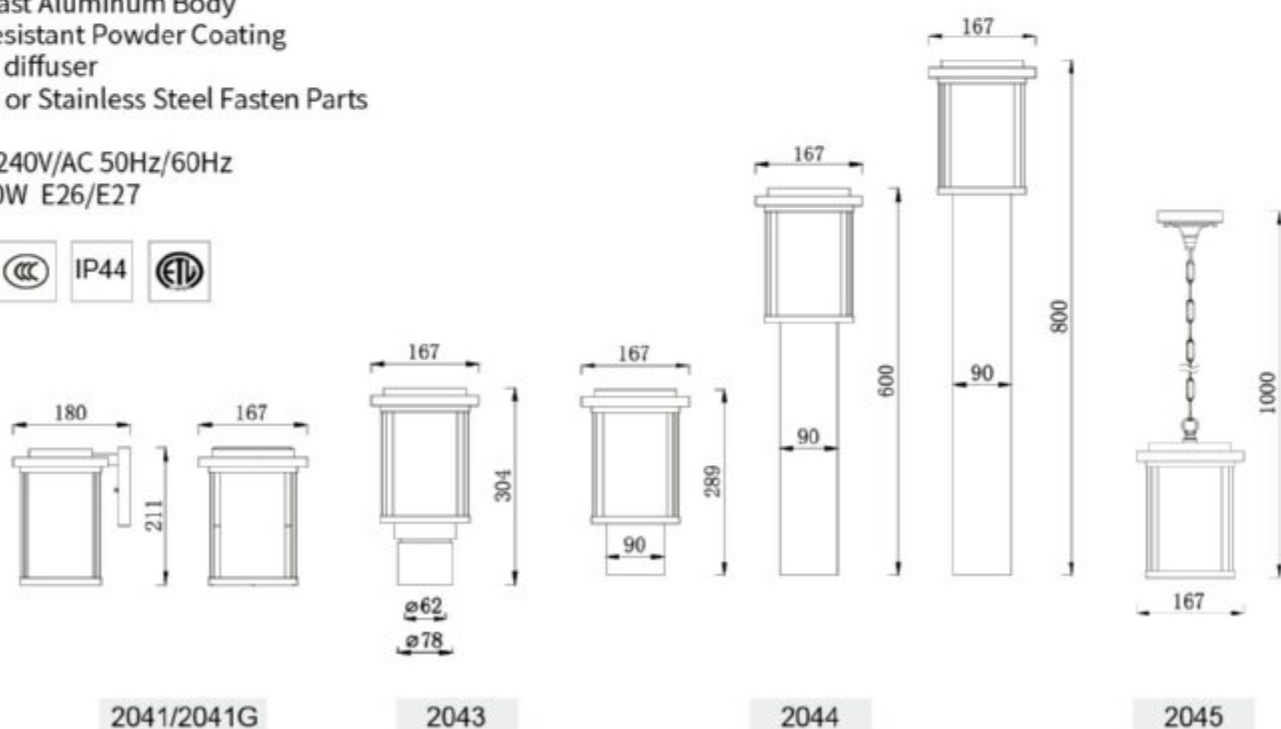

2041/2041G

2043

2044

2045



2041G



2041A

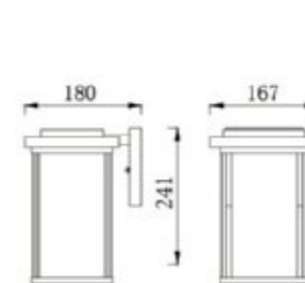

2041A/2041AG

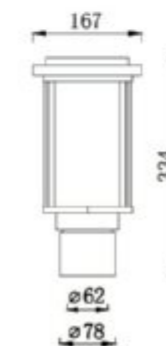

2043A

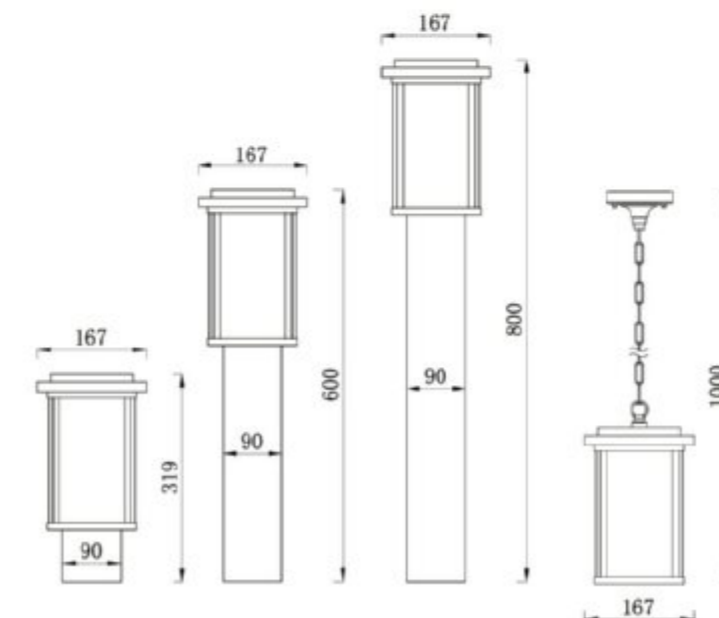

2044A

2045A



<http://www.chinalamp.com>
<http://www.fourstarlamps.com>



2049 2048 2047 20415 20414 20413 20412

Product feature:

- *Die Cast Aluminum Body
- *UV Resistant Powder Coating
- *Glass diffuser
- *Brass or Stainless Steel Fasten Parts

110V~240V/AC 50Hz/60Hz
 Max 60W E26/E27

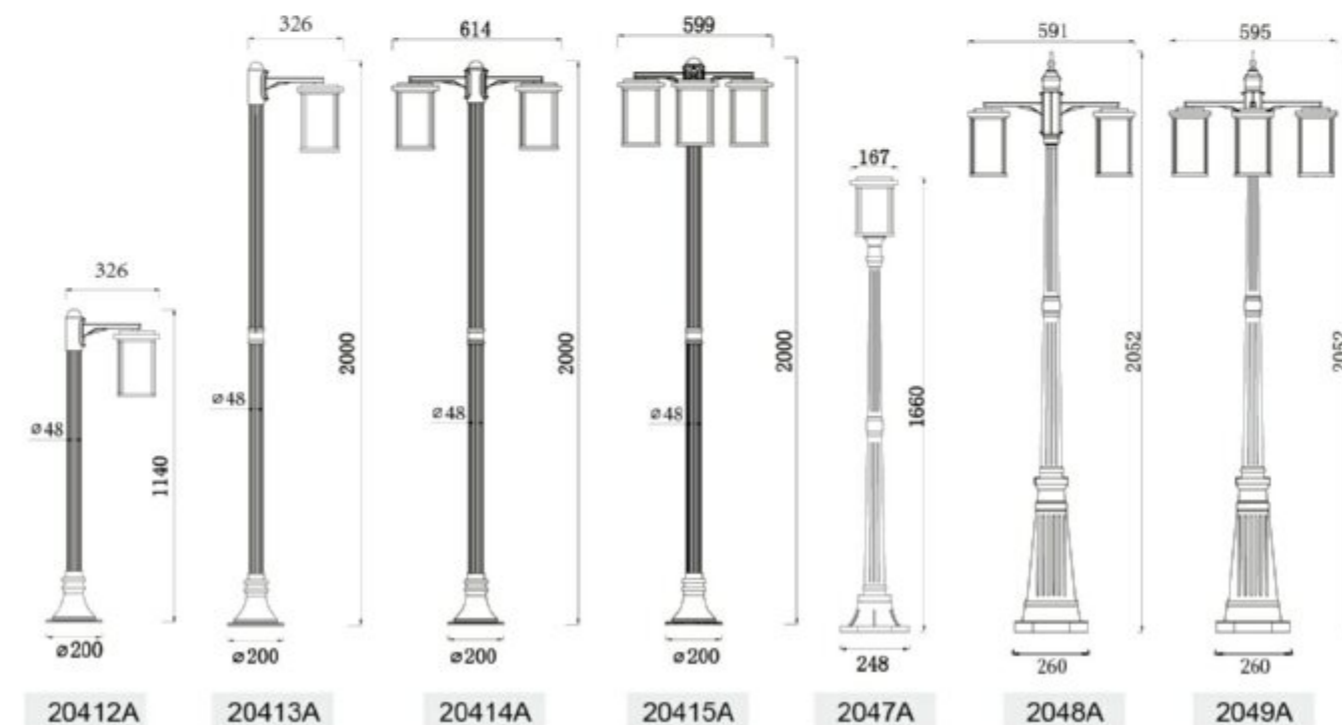
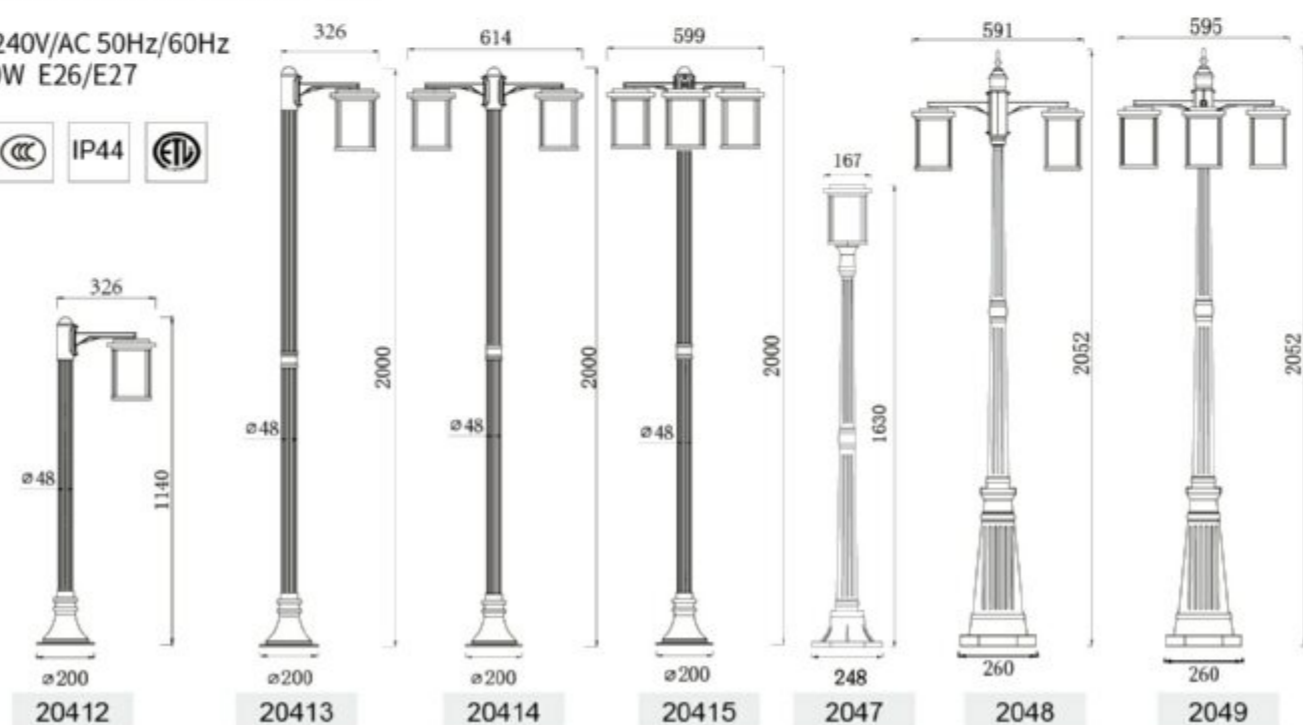



2051



2054

2053



2055

Product feature:

- *Die Cast Aluminum Body
- *UV Resistant Powder Coating
- *Glass diffuser
- *Brass or Stainless Steel Fasten Parts

110V~240V/AC 50Hz/60Hz
 Max 60W E26/E27

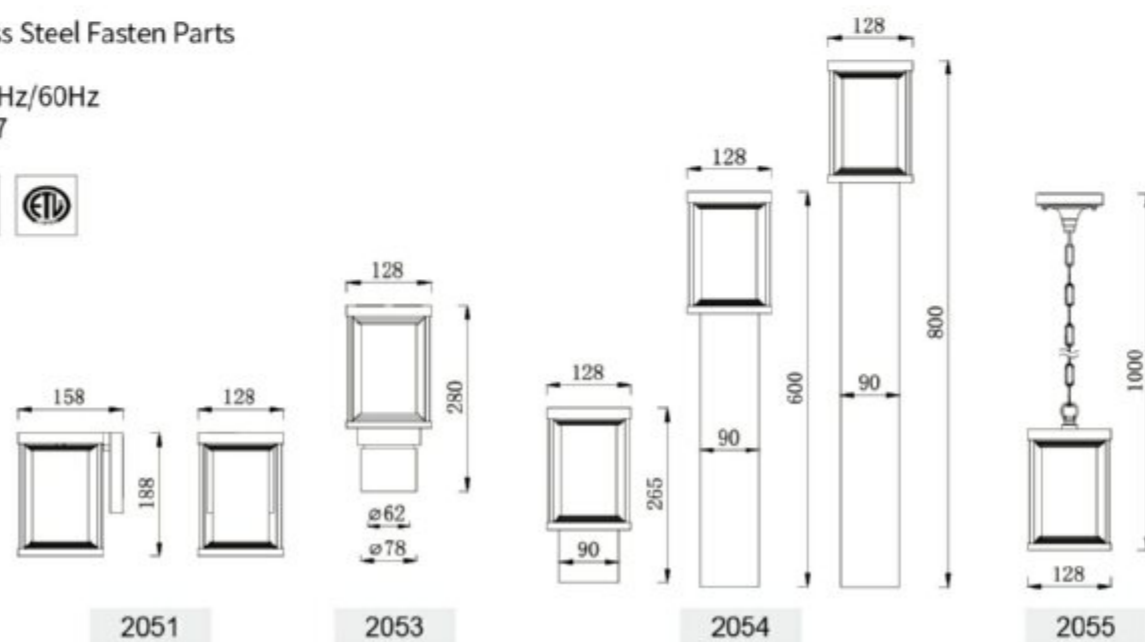

2051A

2053A

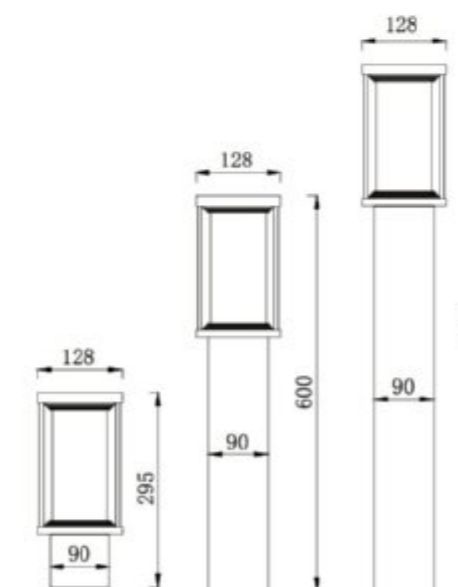

2054A

2055A



2059 2058 2057 20515 20514 20513 20512

Product feature:

- *Die Cast Aluminum Body
- *UV Resistant Powder Coating
- *Glass diffuser
- *Brass or Stainless Steel Fasten Parts

110V~240V/AC 50Hz/60Hz
 Max 60W E26/E27

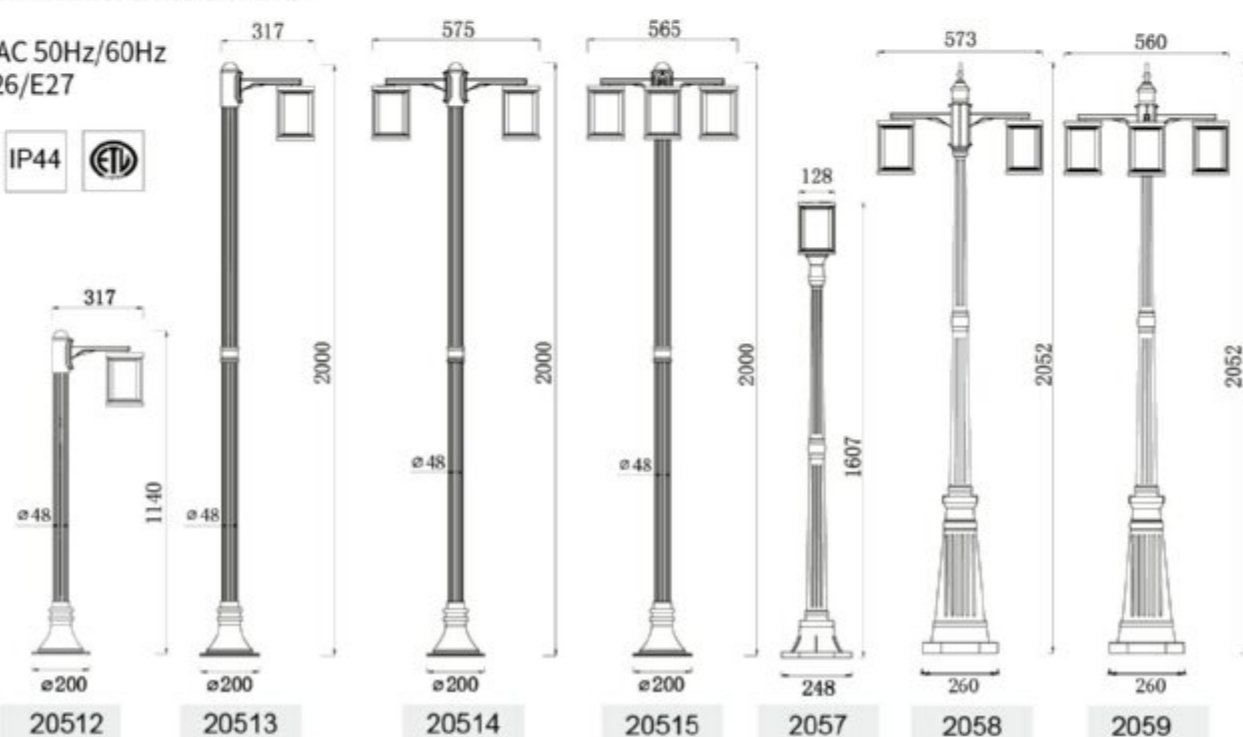

20512 20513 20514 20515 2057 2058 2059

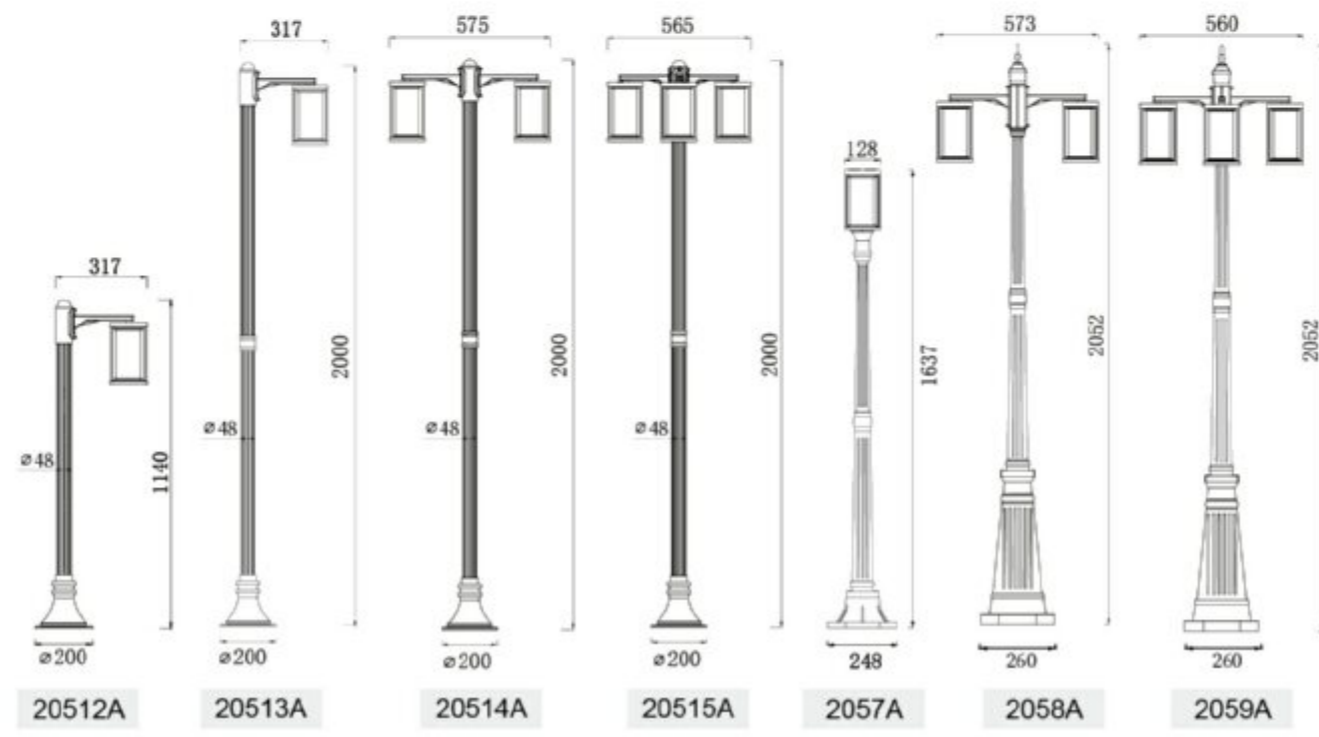

20512A 20513A 20514A 20515A 2057A 2058A 2059A



Product feature:

- *Die Cast Aluminum Body
- *UV Resistant Powder Coating
- *Glass diffuser
- *Brass or Stainless Steel Fasten Parts

110V~240V/AC 50Hz/60Hz
 Max 40W E26/E27

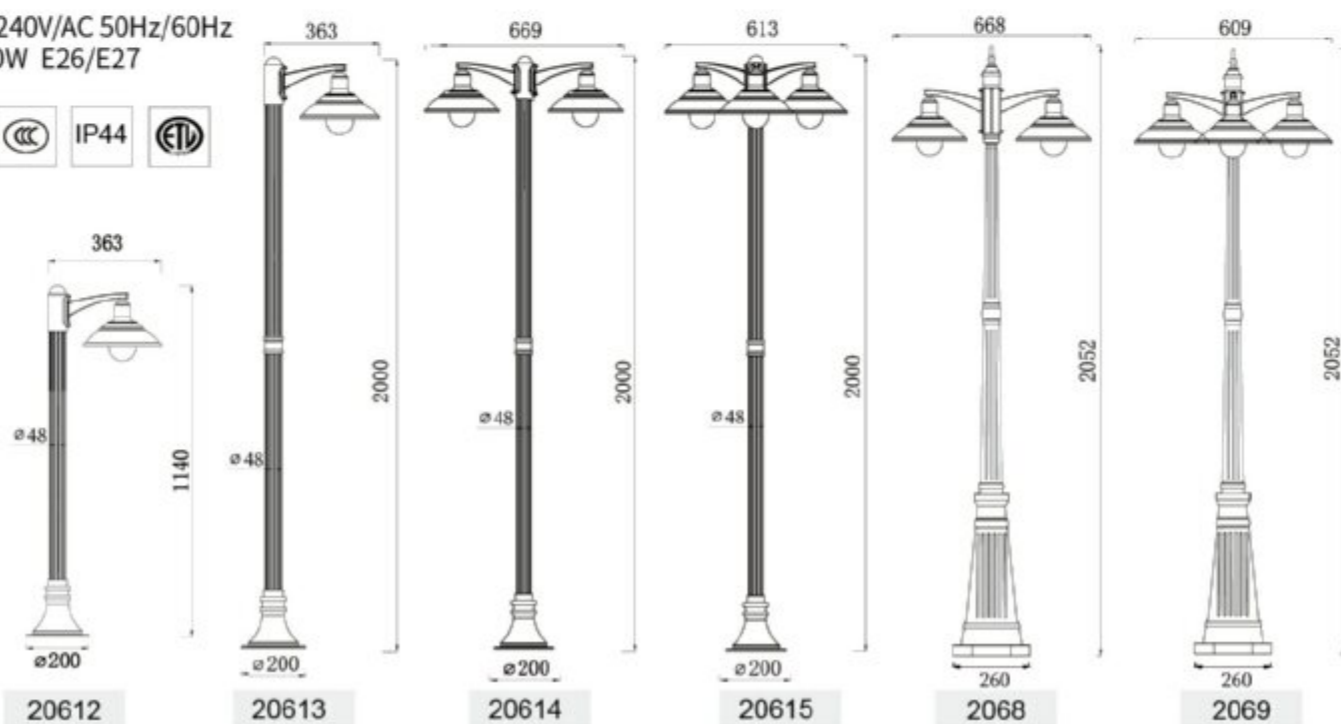

2065



2061



20612



2068

2069

20614

20613

20615



2061

2065



Product feature:

- *Die Cast Aluminum Body
- *UV Resistant Powder Coating
- *Glass diffuser
- *Brass or Stainless Steel Fasten Parts

110V~240V/AC 50Hz/60Hz
Max 40W E26/E27

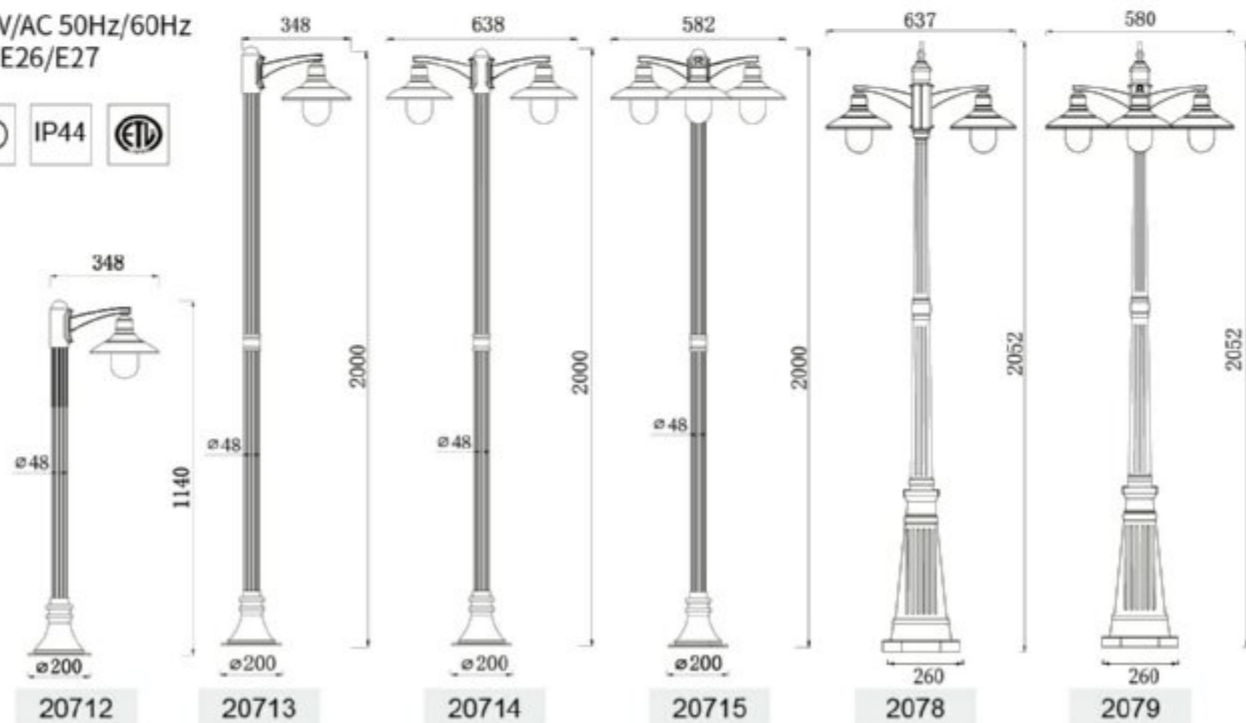

2075



2071



20712



2079

2078

20714

20713

20715

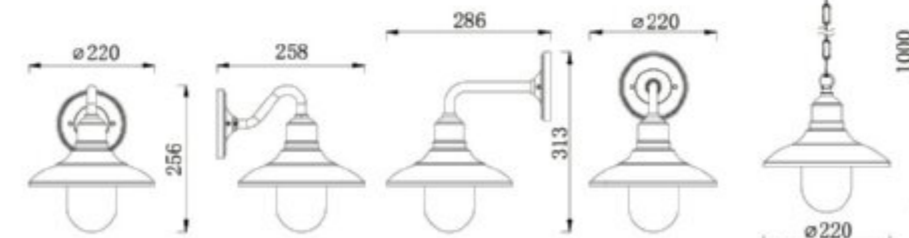

2071

2075



2081



2085



2088

20814

20813

2089

20815

Product feature:

- *Die Cast Aluminum Body
- *UV Resistant Powder Coating
- *Glass diffuser
- *Brass or Stainless Steel Fasten Parts

110V~240V/AC 50Hz/60Hz
 Max 40W E26/E27

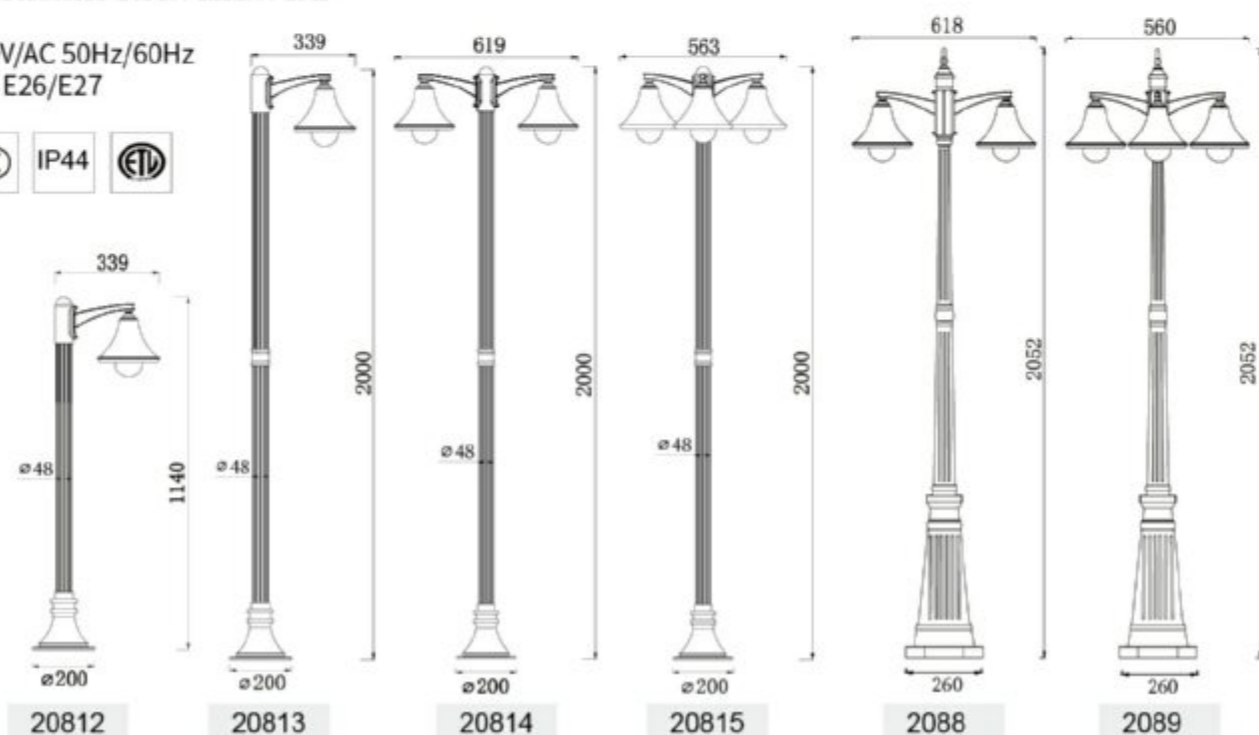

20812



2081

2085